

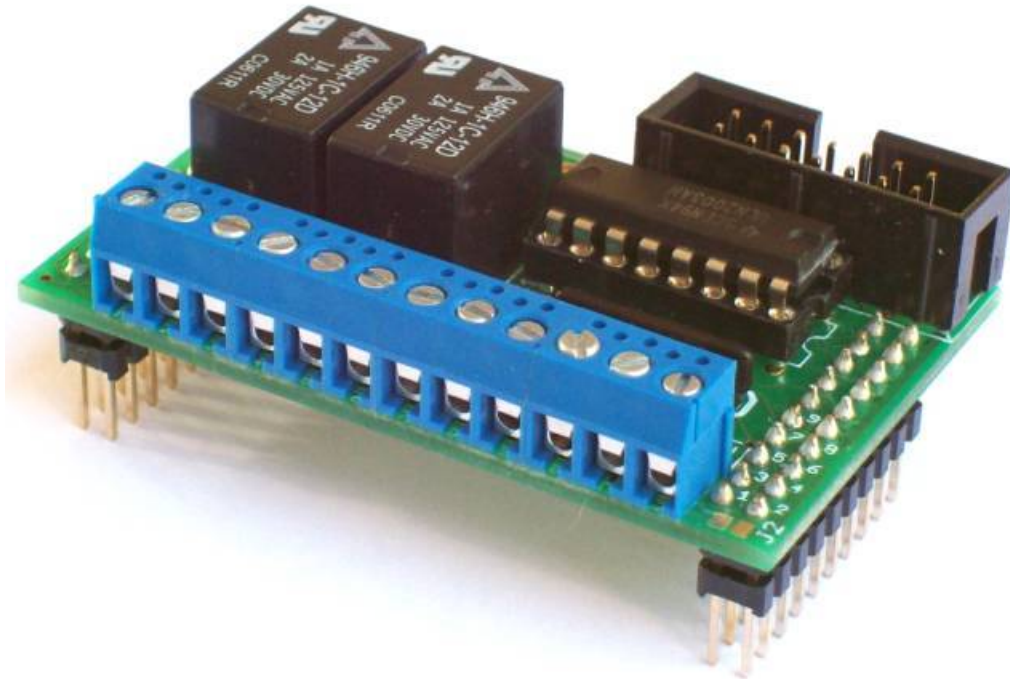

# *MXD2R Revision 1*

## **Input/Output/Relay Daughter Board**



### **Table of Contents**

1 Description.....	2
2 Connectors.....	2
2.1 Daughter Board Connector.....	2
2.2 IDC Connector.....	2
2.3 Terminal Block Connector.....	3
3 Configuration.....	3
4 Specifications.....	3
4.1 Absolute Maximum Ratings.....	3
4.2 Electrical Characteristics.....	4

# 1 Description

The following documentation is for the MXD2R Hardware Revision 1. This board has been designed to be plugged into (daughter board connector) one of our SBC boards, like the SBC28PC, SBC44UC, SBC65EC, SBC68EC.... It has two relays, and a number of analog, open collector and digital inputs and outputs. Additionally it has a 14 pin, 2.54mm IDC connector for expanding the boards I/Os.

It has the following features:

- Can be used as a daughter board on our range or MicroX compact Single Board Computers.
- Two 2A, 30V relay outputs.
- Three Open Collector, digital outputs. Two have a maximum current of 1A, and the third of 500mA. All outputs together must be equal or less than 1A. These outputs connect to the PWM outputs of the SBC board.
- Three Analog inputs, or digital inputs/outputs
- One 14 pin IDC connector with 8 general purpose digital inputs/outputs, GND, 5V and 12V supply.

## 2 Connectors

The MXD2R has 3 connectors, a daughter board connector, IDC connector and terminal block.

### 2.1 Daughter Board Connector

The MXD2R has two 2x10 pin, 2.54mm pin header connectors. These connectors are designed to be plugged into the daughter board connector of a Modtronix compact SBC (single board computer) board. Examples of such SBC boards are the SBC28PC-IR2, SBC28PC-IR4, SBC44UC, SBC65EC, SBC68EC....

### 2.2 IDC Connector

The MXD2R has a 14 pin, 2.54mm IDC connector with port pins, Ground, 5V and V12 signals. The Vext signal is connected to the unregulated power supply of the SBC board, which has to be between 9V and 16V for this board to function properly.

## 2.3 Terminal Block Connector

The MXD2R has two 2x10 pin, 2.54mm pin header connectors. These connectors are designed to be plugged into the daughter board connector of a Modtronix compact SBC (single board computer) board. Examples of such SBC boards are the SBC28PC-IR2, SBC28PC-IR4, SBC44UC, SBC65EC, SBC68EC....

<i>Terminal Block Connector</i>		
<i>Pin</i>	<i>Pin Name</i>	<i>Description</i>
1	RLY2	Relay 2 output
2	RLY2	Relay 2 output
3	RLY1	Relay 1 output
4	RLY1	Relay 1 output
5	O6	Open Collector output, maximum current 500mA. Is controlled by port pin C0 (default) or D0. When the port pin is low, this output is high impedance (no connection). When the port pin is high, this output is pulled low to 0V.
6	O5	Open Collector output, maximum current 500mA. Is controlled by port pin C1. When the port pin is low, this output is high impedance (no connection). When the port pin is high, this output is pulled low to 0V.
7	O4	Open Collector output, maximum current 500mA. Is controlled by port pin C2. When the port pin is low, this output is high impedance (no connection). When the port pin is high, this output is pulled low to 0V.
8	IO3	Analog Input, or Digital Input/Output. This pin is connected via a 1k $\Omega$ to port pin A2. On all SBC boards, port A2 can be configured as an Analog Input, a Digital Input or a Digital Output.
9	IO2	Analog Input, or Digital Input/Output. This pin is connected via a 1k $\Omega$ to port pin A1. On all SBC boards, port A2 can be configured as an Analog Input, a Digital Input or a Digital Output.
10	IO1	Analog Input, or Digital Input/Output. This pin is connected via a 1k $\Omega$ to port pin A0. On all SBC boards, port A2 can be configured as an Analog Input, a Digital Input or a Digital Output.
11	12V	This pin can be configured via solder jumper J2 to be connected to the external input voltage of the SBC board. This is done by default. The SBC board should be powered with 12V, seeing that the relays on this board require 12V.
12	GND	Ground

## 3 Configuration

The MXD2R can be configured via 3 solder jumpers. All these solder jumpers have already been enabled with default connections.

Solder jumper J1 is located on the bottom of the board. It controls what port pin is used for output O6. For details, see “Terminal Block Connector” section above. By default, C0 is selected.

Solder jumper J2 selects if the external input voltage of the SBC board is connected to the external voltage pin of this board.. This jumper is made by default.

Solder jumper J3 is located on the bottom of the board. It controls what port pin is used for pin 2 of the IDC connector. For details, see the schematics below. By default, T7 is selected.

## 4 Specifications

### 4.1 Absolute Maximum Ratings

<i>Item</i>	<i>Symbol</i>	<i>Min</i>	<i>Typ</i>	<i>Max</i>	<i>Unit</i>
Operating Temperature of MXD2R	Topnd	-20		+70	°C

## 4.2 Electrical Characteristics

<i>Item</i>	<i>Symbol</i>	<i>Condition</i>	<i>Min</i>	<i>Typ</i>	<i>Max</i>	<i>Unit</i>
DC Supply Voltage:	Vdd	-	9		16	V

**Daughter Board Connector**

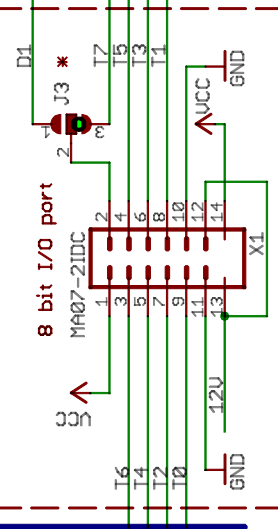
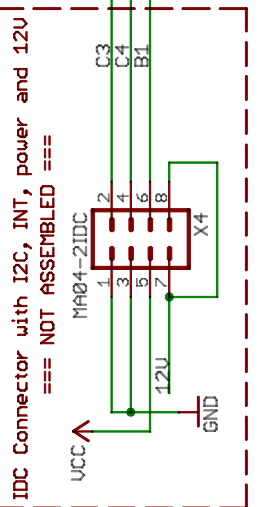
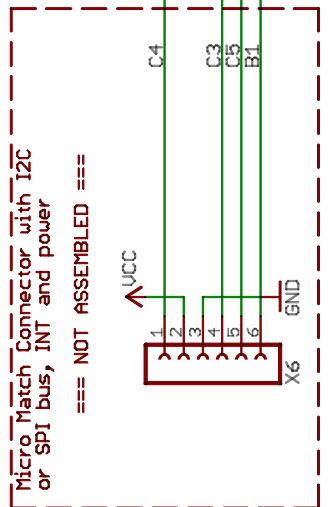
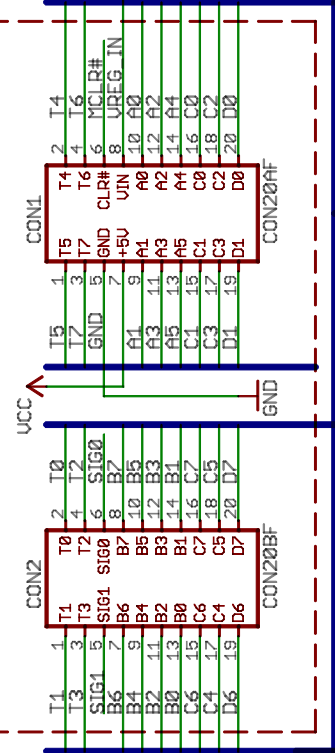

\* Daughter board signal T7 or D1 can be selected via a solder jumper. By default, T7 is selected. On the SBC65/68EC boards T7 might not be available if a FRAM chip has been assembled. On a standard SBC65/68EC board T7 is available.

\*\* Daughter board signal C0 or D0 can be selected via a solder jumper. By default, C0 is selected. On some boards (SBC65EC) D0 is a PWM output, and might want to be used. Other boards don't have D0, and will use C0.

● Indicates default solder jumper that is made at delivery

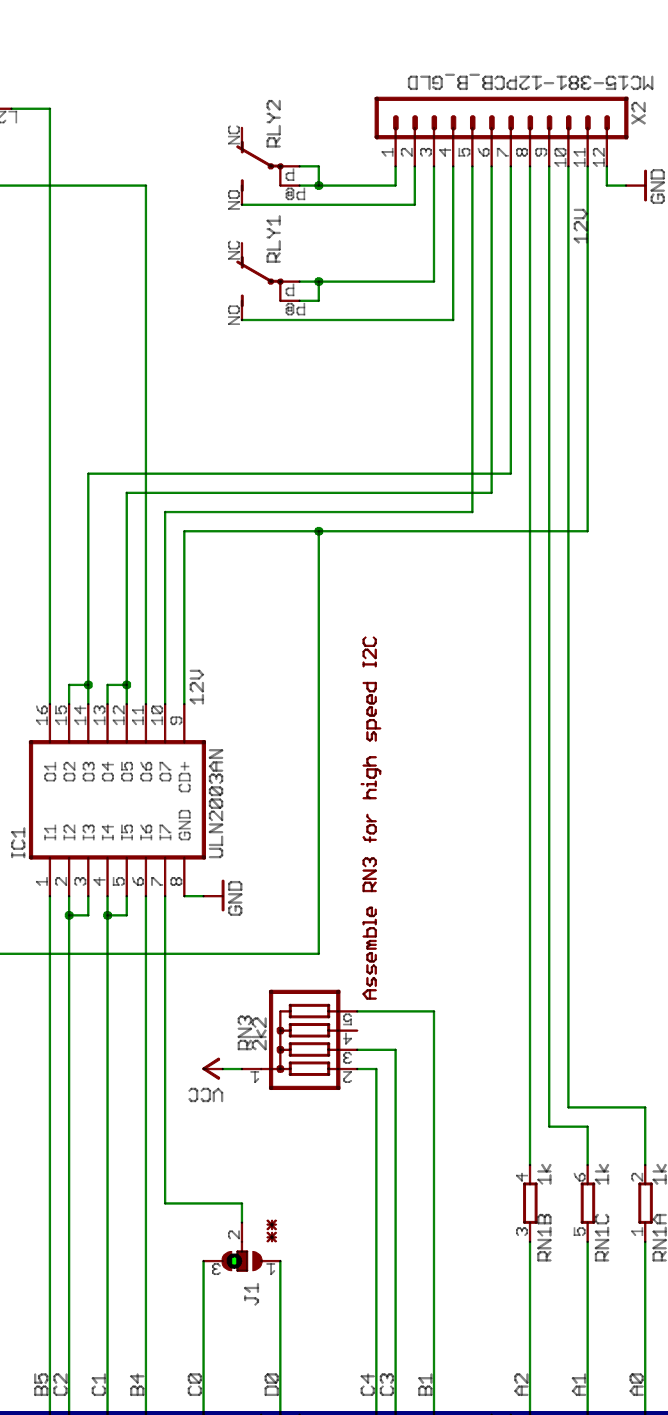
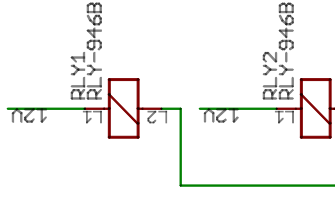

Compact Daughter Board with 2 Relays and 6 I/Os	
TITLE: mxd2r_doc	
Document Number:	
REV:	
Date: 7/13/2007 03:36:10p	Sheet: 1/1